



## Rectangle Duct and Fittings Construction Standards

### Positive and Negative Pressure

Gauge selection for galvanized steel (ASTM A653), paint grip steel, type 304 stainless steel, and poly coated steel (PCS/PVC). Adjustments must be made for the use of 3003 aluminum. Standard seams are Pittsburgh lock, type L-1, for both pipe and fittings. All seams are factory sealed.

Legend: Corken Steel offers two types of intermediate reinforcement for rectangular ductwork: external reinforcement and mid panel tie rods. Tie rods at the duct joints will be provided where required in addition to the intermediate reinforcement. Two construction tables for each pressure class are provided, corresponding to each reinforcement method.

#### EXTERIOR REINFORCEMENT

Maximum Duct Dimension	Gauge	Conn	Joint Tie Rods #	Center Rein. #	Rein. Tie Rods #
0 to 8	26	FS/D	N/R	N/R	N/R
9 to 10	26	FS/D	N/R	N/R	N/R
11 to 12	26	FS/D	N/R	N/R	N/R
13 to 14	26	FS/D	N/R	N/R	N/R
15 to 16	26	FS/D	N/R	N/R	N/R
17 to 18	26	FS/D	N/R	N/R	N/R
19 to 20	26	FS/D	N/R	N/R	N/R
21 to 22	26	SS/D	N/R	N/R	N/R
23 to 24	26	SS/D	N/R	N/R	N/R
25 to 26	26	SS/D	N/R	N/R	N/R
27 to 28	24	TDC	N/R	N/R	N/R
29 to 30	24	TDC	N/R	N/R	N/R
31 to 36	26	TDC	N/R	N/R	N/R
37 to 42	24	TDC	N/R	1	N/R
43 to 48	22	TDC	N/R	1	N/R
49 to 54	26	TDC	N/R	1	N/R
55 to 60	26	TDC	1	1	N/R
61 to 72	20	TDC	1	1	N/R
73 to 84	20	TDC	1	1	1
85 to 96	20	TDC	1	1	1
97 to 108	18	TDC	2	1	2
109 to 120	18	TDC	2	1	2

#### MID PANEL TIE ROD REINFORCEMENT

Maximum Duct Dimension	Gauge	Conn	Joint Tie Rods #	Mid Panel Tie Rods#
0 to 8	26	FS/D	N/R	N/R
9 to 10	26	FS/D	N/R	N/R
11 to 12	26	FS/D	N/R	N/R
13 to 14	26	FS/D	N/R	N/R
15 to 16	26	FS/D	N/R	N/R
17 to 18	26	FS/D	N/R	N/R
19 to 20	26	FS/D	N/R	N/R
21 to 22	26	SS/D	N/R	N/R
23 to 24	26	SS/D	N/R	N/R
25 to 26	26	SS/D	N/R	N/R
27 to 28	24	TDC	N/R	N/R
29 to 30	24	TDC	N/R	N/R
31 to 36	26	TDC	N/R	N/R
37 to 42	24	TDC	N/R	1
43 to 48	22	TDC	N/R	1
49 to 54	26	TDC	N/R	1
55 to 60	26	TDC	1	1
61 to 72	20	TDC	1	1
73 to 84	20	TDC	1	1
85 to 96	20	TDC	1	1
97 to 108	18	TDC	2	EXT
109 to 120	18	TDC	2	EXT

FS/D = Flat Slip (T-6) and Drive (T-1)  
 SS/D = Standing Slip (T-10) and Drive (T-1)  
 TDC = 4 Bolt Connection (T-25b)  
 N/R = Not Required  
 EXT = Use External Reinforcement

Corken Steel will fabricate to any specified construction or shop standard. Please see page 6 for available seams and connections.

#### MATERIAL AND GAUGE AVAILABILITY

Galvanized Steel	26 to 16 gauge
Paint Grip Steel	26 to 16 gauge
<i>Material sold as Paint Grip is not "ready to paint" – It will require cleaning.</i>	
304 Stainless	24 and 22 gauge
PCS/PVC	24 gauge
<i>PCS/PVC is not recommended for use in high visibility applications.</i>	
Aluminum	.032, .040, .063, .080, .090
Carbon Steel	16 gauge

#### ALUMINUM (3003) DUCT THICKNESS ADJUSTMENTS

Steel Gauge	Aluminum Thickness
26	.025"
24	.032"
22	.040"
20	.050"
18	.065"
16	.080"
14	.109"



## Rectangle Duct and Fittings Construction Standard

### 1/2" WG – 5ft. Duct Gauge and Reinforcement Selection • Maximum Drive: 18"

#### EXTERIOR REINFORCEMENT

Maximum Duct		Gauge	Conn	Joint Tie	Center	Rein. Tie
Dimension	Rods #			Rein. #	Rods #	
0 to 8	26	26	FS/D	N/R	N/R	N/R
9 to 10	26	26	FS/D	N/R	N/R	N/R
11 to 12	26	26	FS/D	N/R	N/R	N/R
13 to 14	26	26	FS/D	N/R	N/R	N/R
15 to 16	26	26	FS/D	N/R	N/R	N/R
17 to 18	26	26	FS/D	N/R	N/R	N/R
19 to 20	26	26	FS/D	N/R	N/R	N/R
21 to 22	26	26	SS/D	N/R	N/R	N/R
23 to 24	26	26	SS/D	N/R	N/R	N/R
25 to 26	26	26	SS/D	N/R	N/R	N/R
27 to 28	26	26	TDC	N/R	N/R	N/R
29 to 30	26	26	TDC	N/R	N/R	N/R
31 to 36	26	26	TDC	N/R	N/R	N/R
37 to 42	26	26	TDC	N/R	1	N/R
43 to 48	24	24	TDC	N/R	1	N/R
49 to 54	24	24	TDC	1	1	N/R
55 to 60	24	24	TDC	1	1	N/R
61 to 72	22	22	TDC	1	1	N/R
73 to 84	22	22	TDC	1	1	N/R
85 to 96	22	22	TDC	1	1	N/R
97 to 108	18	18	TDC	1	1	N/R
109 to 120	18	18	TDC	1	1	N/R

#### MID PANEL TIE ROD REINFORCEMENT

Maximum Duct		Gauge	Conn	Joint Tie	Mid Panel
Dimension	Rods #			Rods #	Tie Rods#
0 to 8	26	26	FS/D	N/R	N/R
9 to 10	26	26	FS/D	N/R	N/R
11 to 12	26	26	FS/D	N/R	N/R
13 to 14	26	26	FS/D	N/R	N/R
15 to 16	26	26	FS/D	N/R	N/R
17 to 18	26	26	FS/D	N/R	N/R
19 to 20	26	26	FS/D	N/R	N/R
21 to 22	26	26	SS/D	N/R	N/R
23 to 24	26	26	SS/D	N/R	N/R
25 to 26	26	26	SS/D	N/R	N/R
27 to 28	26	26	TDC	N/R	N/R
29 to 30	26	26	TDC	N/R	N/R
31 to 36	26	26	TDC	N/R	N/R
37 to 42	26	26	TDC	N/R	N/R
43 to 48	24	24	TDC	N/R	N/R
49 to 54	24	24	TDC	N/R	1
55 to 60	24	24	TDC	N/R	1
61 to 72	22	22	TDC	N/R	1
73 to 84	22	22	TDC	N/R	1
85 to 96	22	22	TDC	N/R	1
97 to 108	18	18	TDC	N/R	EXT
109 to 120	18	18	TDC	N/R	EXT

### 1" WG – 5ft. Duct Gauge and Reinforcement Selection • Maximum Drive: 18"

#### EXTERIOR REINFORCEMENT

Maximum Duct		Gauge	Conn	Joint Tie	Center	Rein. Tie
Dimension	Rods #			Rein. #	Rods #	
0 to 8	26	26	FS/D	N/R	N/R	N/R
9 to 10	26	26	FS/D	N/R	N/R	N/R
11 to 12	26	26	FS/D	N/R	N/R	N/R
13 to 14	26	26	FS/D	N/R	N/R	N/R
15 to 16	26	26	FS/D	N/R	N/R	N/R
17 to 18	26	26	FS/D	N/R	N/R	N/R
19 to 20	26	26	FS/D	N/R	N/R	N/R
21 to 22	26	26	SS/D	N/R	N/R	N/R
23 to 24	26	26	SS/D	N/R	N/R	N/R
25 to 26	26	26	SS/D	N/R	N/R	N/R
27 to 28	26	26	TDC	N/R	N/R	N/R
29 to 30	26	26	TDC	N/R	N/R	N/R
31 to 36	24	24	TDC	N/R	N/R	N/R
37 to 42	24	24	TDC	N/R	N/R	N/R
43 to 48	22	22	TDC	N/R	N/R	N/R
49 to 54	22	22	TDC	N/R	N/R	N/R
55 to 60	24	24	TDC	N/R	1	N/R
61 to 72	24	24	TDC	N/R	1	N/R
73 to 84	22	22	TDC	1	1	N/R
85 to 96	20	20	TDC	1	1	N/R
97 to 108	18	18	TDC	2	1	2
109 to 120	18	18	TDC	2	1	2

#### MID PANEL TIE ROD REINFORCEMENT

Maximum Duct		Gauge	Conn	Joint Tie	Mid Panel
Dimension	Rods #			Rods #	Tie Rods#
0 to 8	26	26	FS/D	N/R	N/R
9 to 10	26	26	FS/D	N/R	N/R
11 to 12	26	26	FS/D	N/R	N/R
13 to 14	26	26	FS/D	N/R	N/R
15 to 16	26	26	FS/D	N/R	N/R
17 to 18	26	26	FS/D	N/R	N/R
19 to 20	26	26	FS/D	N/R	N/R
21 to 22	26	26	SS/D	N/R	N/R
23 to 24	26	26	SS/D	N/R	N/R
25 to 26	26	26	SS/D	N/R	N/R
27 to 28	26	26	TDC	N/R	N/R
29 to 30	26	26	TDC	N/R	N/R
31 to 36	24	24	TDC	N/R	N/R
37 to 42	24	24	TDC	N/R	N/R
43 to 48	22	22	TDC	N/R	N/R
49 to 54	22	22	TDC	N/R	N/R
55 to 60	24	24	TDC	N/R	1
61 to 72	24	24	TDC	N/R	2
73 to 84	22	22	TDC	1	2
85 to 96	20	20	TDC	1	2
97 to 108	18	18	TDC	2	EXT
109 to 120	18	18	TDC	2	EXT



## Rectangle Duct and Fittings Construction Standard

### 2" WG – 5ft. Duct Gauge and Reinforcement Selection • Maximum Drive: 18"

#### EXTERIOR REINFORCEMENT

Maximum Duct		Gauge	Conn	Joint Tie	Center	Rein. Tie
Dimension	Rods #			Rein. #	Rods #	
0 to 8	26	FS/D	N/R	N/R	N/R	
9 to 10	26	FS/D	N/R	N/R	N/R	
11 to 12	26	FS/D	N/R	N/R	N/R	
13 to 14	26	FS/D	N/R	N/R	N/R	
15 to 16	26	FS/D	N/R	N/R	N/R	
17 to 18	26	FS/D	N/R	N/R	N/R	
19 to 20	26	FS/D	N/R	N/R	N/R	
21 to 22	26	SS/D	N/R	N/R	N/R	
23 to 24	26	SS/D	N/R	N/R	N/R	
25 to 26	26	SS/D	N/R	N/R	N/R	
27 to 28	24	TDC	N/R	N/R	N/R	
29 to 30	24	TDC	N/R	N/R	N/R	
31 to 36	26	TDC	N/R	N/R	N/R	
37 to 42	24	TDC	N/R	1	N/R	
43 to 48	22	TDC	N/R	1	N/R	
49 to 54	22	TDC	N/R	1	N/R	
55 to 60	22	TDC	1	1	N/R	
61 to 72	20	TDC	1	1	N/R	
73 to 84	20	TDC	1	1	1	
85 to 96	20	TDC	1	1	1	
97 to 108	18	TDC	2	1	2	
109 to 120	18	TDC	2	1	2	

#### MID PANEL TIE ROD REINFORCEMENT

Maximum Duct		Gauge	Conn	Joint Tie	Mid Panel
Dimension	Rods #			Tie	Rods#
0 to 8	26	FS/D	N/R	N/R	
9 to 10	26	FS/D	N/R	N/R	
11 to 12	26	FS/D	N/R	N/R	
13 to 14	26	FS/D	N/R	N/R	
15 to 16	26	FS/D	N/R	N/R	
17 to 18	26	FS/D	N/R	N/R	
19 to 20	26	FS/D	N/R	N/R	
21 to 22	26	SS/D	N/R	N/R	
23 to 24	26	SS/D	N/R	N/R	
25 to 26	26	SS/D	N/R	N/R	
27 to 28	24	TDC	N/R	N/R	
29 to 30	24	TDC	N/R	N/R	
31 to 36	26	TDC	N/R	N/R	
37 to 42	24	TDC	N/R	1	
43 to 48	22	TDC	N/R	1	
49 to 54	22	TDC	N/R	1	
55 to 60	22	TDC	1	1	
61 to 72	20	TDC	1	1	
73 to 84	20	TDC	1	2	
85 to 96	20	TDC	1	2	
97 to 108	18	TDC	2	EXT	
109 to 120	18	TDC	2	EXT	

### 3" WG – 5ft. Duct Gauge and Reinforcement Selection • Maximum Drive: 18"

#### EXTERIOR REINFORCEMENT

Maximum Duct		Gauge	Conn	Joint Tie	Center	Rein. Tie
Dimension	Rods #			Rein. #	Rods #	
0 to 8	26	TDC	N/R	N/R	N/R	
9 to 10	26	TDC	N/R	N/R	N/R	
11 to 12	26	TDC	N/R	N/R	N/R	
13 to 14	24	TDC	N/R	N/R	N/R	
15 to 16	24	TDC	N/R	N/R	N/R	
17 to 18	24	TDC	N/R	N/R	N/R	
19 to 20	24	TDC	N/R	N/R	N/R	
21 to 22	24	TDC	N/R	N/R	N/R	
23 to 24	24	TDC	N/R	N/R	N/R	
25 to 26	24	TDC	N/R	N/R	N/R	
27 to 28	22	TDC	N/R	N/R	N/R	
29 to 30	22	TDC	N/R	N/R	N/R	
31 to 36	24	TDC	N/R	1	N/R	
37 to 42	22	TDC	N/R	1	N/R	
43 to 48	22	TDC	1	1	N/R	
49 to 54	22	TDC	1	1	N/R	
55 to 60	20	TDC	1	1	N/R	
61 to 72	20	TDC	1	1	1	
73 to 84	20	TDC	1	1	1	
85 to 96	18	TDC	1	1	1	
97 to 108	18	TDC	2	1	2	
109 to 120	18	TDC	2	1	2	

#### MID PANEL TIE ROD REINFORCEMENT

Maximum Duct		Gauge	Conn	Joint Tie	Mid Panel
Dimension	Rods #			Tie	Rods#
0 to 8	26	TDC	N/R	N/R	
9 to 10	26	TDC	N/R	N/R	
11 to 12	26	TDC	N/R	N/R	
13 to 14	24	TDC	N/R	N/R	
15 to 16	24	TDC	N/R	N/R	
17 to 18	24	TDC	N/R	N/R	
19 to 20	24	TDC	N/R	N/R	
21 to 22	24	TDC	N/R	N/R	
23 to 24	24	TDC	N/R	N/R	
25 to 26	24	TDC	N/R	N/R	
27 to 28	22	TDC	N/R	N/R	
29 to 30	22	TDC	N/R	N/R	
31 to 36	24	TDC	N/R	1	
37 to 42	22	TDC	N/R	1	
43 to 48	22	TDC	1	1	
49 to 54	22	TDC	1	1	
55 to 60	20	TDC	1	1	
61 to 72	20	TDC	1	2	
73 to 84	20	TDC	1	2	
85 to 96	18	TDC	1	2	
97 to 108	18	TDC	2	EXT	
109 to 120	18	TDC	2	EXT	



## Rectangle Duct and Fittings Construction Standard

### 4" WG – 5ft. Duct Gauge and Reinforcement Selection • Maximum Drive: 18"

#### EXTERIOR REINFORCEMENT

Maximum Duct		Gauge	Conn	Joint Tie	Center	Rein. Tie
Dimension	Rods #			Rein. #	Rods #	
0 to 8	26	TDC	N/R	N/R	N/R	
9 to 10	26	TDC	N/R	N/R	N/R	
11 to 12	26	TDC	N/R	N/R	N/R	
13 to 14	24	TDC	N/R	N/R	N/R	
15 to 16	24	TDC	N/R	N/R	N/R	
17 to 18	24	TDC	N/R	N/R	N/R	
19 to 20	24	TDC	N/R	N/R	N/R	
21 to 22	24	TDC	N/R	N/R	N/R	
23 to 24	22	TDC	N/R	N/R	N/R	
25 to 26	22	TDC	N/R	N/R	N/R	
27 to 28	22	TDC	N/R	N/R	N/R	
29 to 30	24	TDC	N/R	1	N/R	
31 to 36	22	TDC	N/R	1	N/R	
37 to 42	22	TDC	1	1	N/R	
43 to 48	20	TDC	1	1	N/R	
49 to 54	20	TDC	1	1	N/R	
55 to 60	20	TDC	1	1	1	
61 to 72	20	TDC	1	1	1	
73 to 84	18	TDC	1	1	1	
85 to 96	18	TDC	1	1	1	
97 to 108	18	TDC	2	1	2	
109 to 120	18	TDC	2	1	2	

#### MID PANEL TIE ROD REINFORCEMENT

Maximum Duct		Gauge	Conn	Joint Tie	Mid Panel
Dimension	Rods #			Tie Rods#	
0 to 8	26	TDC	N/R	N/R	
9 to 10	26	TDC	N/R	N/R	
11 to 12	26	TDC	N/R	N/R	
13 to 14	26	TDC	N/R	N/R	
15 to 16	26	TDC	N/R	N/R	
17 to 18	26	TDC	N/R	N/R	
19 to 20	26	TDC	N/R	N/R	
21 to 22	26	TDC	N/R	N/R	
23 to 24	26	TDC	N/R	N/R	
25 to 26	26	TDC	N/R	N/R	
27 to 28	26	TDC	N/R	N/R	
29 to 30	26	TDC	N/R	N/R	
31 to 36	26	TDC	N/R	N/R	
37 to 42	26	TDC	N/R	N/R	
43 to 48	24	TDC	N/R	N/R	
49 to 54	24	TDC	N/R	1	
55 to 60	24	TDC	N/R	1	
61 to 72	22	TDC	N/R	1	
73 to 84	22	TDC	N/R	1	
85 to 96	22	TDC	N/R	1	
97 to 108	18	TDC	N/R	EXT	
109 to 120	18	TDC	N/R	EXT	

### 6" WG – 5ft. Duct Gauge and Reinforcement Selection • Maximum Drive: 18"

#### EXTERIOR REINFORCEMENT

Maximum Duct		Gauge	Conn	Joint Tie	Center	Rein. Tie
Dimension	Rods #			Rein. #	Rods #	
0 to 8	24	TDC	N/R	N/R	N/R	
9 to 10	24	TDC	N/R	N/R	N/R	
11 to 12	24	TDC	N/R	N/R	N/R	
13 to 14	26	TDC	N/R	1	N/R	
15 to 16	26	TDC	N/R	1	N/R	
17 to 18	26	TDC	N/R	1	N/R	
19 to 20	26	TDC	N/R	1	N/R	
21 to 22	24	TDC	N/R	1	N/R	
23 to 24	24	TDC	N/R	1	N/R	
25 to 26	24	TDC	N/R	1	N/R	
27 to 28	22	TDC	N/R	1	N/R	
29 to 30	22	TDC	N/R	1	N/R	
31 to 36	20	TDC	N/R	1	N/R	
37 to 42	20	TDC	1	1	N/R	
43 to 48	20	TDC	1	1	1	
49 to 54	20	TDC	1	1	1	
55 to 60	20	TDC	1	1	1	
61 to 72	18	TDC	1	1	1	
73 to 84	18	TDC	1	1	1	
85 to 96	16	TDC	1	1	1	
97 to 108	16	TDC	2	1	2	
109 to 120	16	TDC	2	1	2	

#### MID PANEL TIE ROD REINFORCEMENT

Maximum Duct		Gauge	Conn	Joint Tie	Mid Panel
Dimension	Rods #			Tie Rods#	
0 to 8	26	TDC	N/R	N/R	
9 to 10	26	TDC	N/R	N/R	
11 to 12	26	TDC	N/R	N/R	
13 to 14	26	TDC	N/R	N/R	
15 to 16	26	TDC	N/R	N/R	
17 to 18	26	TDC	N/R	N/R	
19 to 20	26	TDC	N/R	N/R	
21 to 22	26	TDC	N/R	N/R	
23 to 24	26	TDC	N/R	N/R	
25 to 26	26	TDC	N/R	N/R	
27 to 28	26	TDC	N/R	N/R	
29 to 30	26	TDC	N/R	N/R	
31 to 36	26	TDC	N/R	N/R	
37 to 42	26	TDC	N/R	N/R	
43 to 48	24	TDC	N/R	N/R	
49 to 54	24	TDC	N/R	1	
55 to 60	24	TDC	N/R	1	
61 to 72	22	TDC	N/R	1	
73 to 84	22	TDC	N/R	1	
85 to 96	22	TDC	N/R	1	
97 to 108	18	TDC	N/R	EXT	
109 to 120	18	TDC	N/R	EXT	



### Connector Types



T-1 Drive Slip



T-6 Hemmed "S" Slip

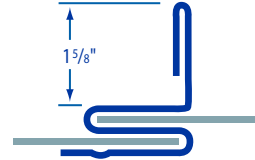

T-10 Standing S



T-21 Weld Flange

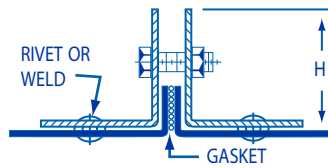

T-22 Companion Angles

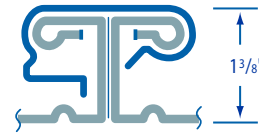

T-25b Flanged

### Seam Types (Fig. 1-5)



L-1 Pittsburgh Lock



L-2 Button Punch Snap Lock



L-4 Standing Seam



L-5 Single Corner Seam



Corner Weld



# SINGLE WALL RECTANGULAR

## Reinforcement

### Immediate Reinforcement

#### H REINFORCEMENT

Rollformed from 24 gauge galvanized steel. Conforms to SMACNA "H" equivalent.

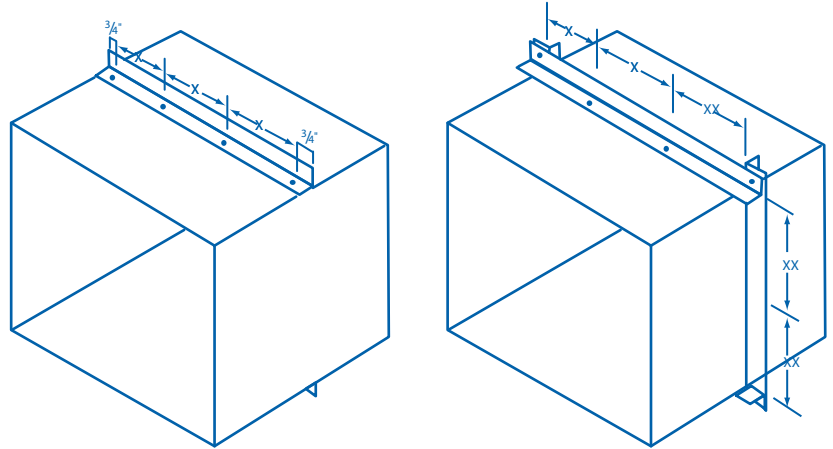
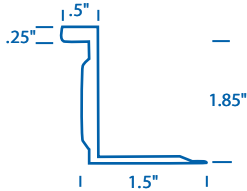

X = 8" Maximum fastener (tack weld, spotweld, bolt, screw, or rivet) spacing when ends are tied, the 3/4" interval may be omitted.

When reinforcements occur at the same location on adjacent sides at 4" WG (1000 Pa) static and over, tie the ends.

For duct  $\geq 4$ " WG, ends of reinforcement must be tied together.

### Tie Rods

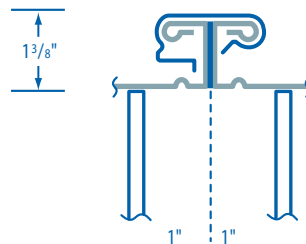
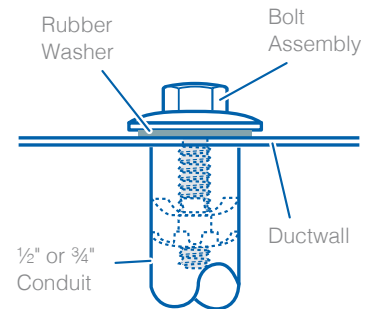
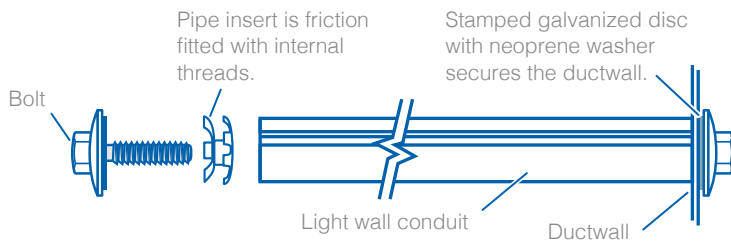

Each duct section is tied at both ends



### Stock Liner

½" - 2 lb. density liner

1" - 1½ lb. density liner

*Other thicknesses and densities available upon request.*

### Liner Installation

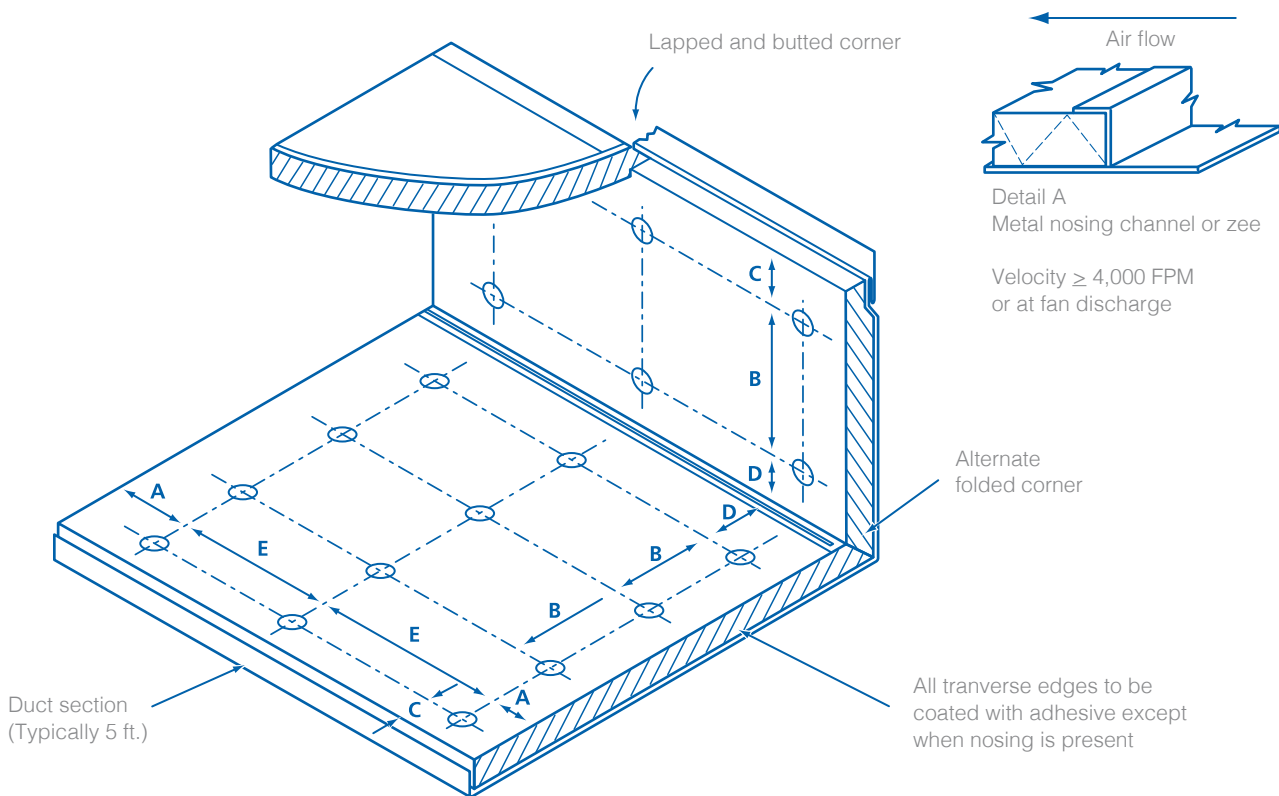

### Technical Data

Fire Resistance: Meets NFPA 90A and NFPA 90B Standards for fire safety.

Temperature Range: ASTM C 411. Up to +250° (+121°C)

Air Velocity: ASTM C 1071

Maximum 6000 fpm (1829 mpm)

Water Vapor Sorption: ASTM C 2204. Less than 3% by weight.

Surface Burning Characteristics: UL/ULC Listed. When tested in accordance with ASTM E 84, UL 723, CAN 4-S102, and NFPA-255, Johns-Manville Linacoustic® RC does not exceed: 25 Flame spread, 50 Smoke developed.

Microbial Growth: ASTM C1388, G21, G22. The airstream surface mat facing is treated with an EPA registered antimicrobial agent to aid in the prevention of fungal and bacterial growth.



# SINGLE WALL RECTANGULAR

## Vanes

### Dual Vanes

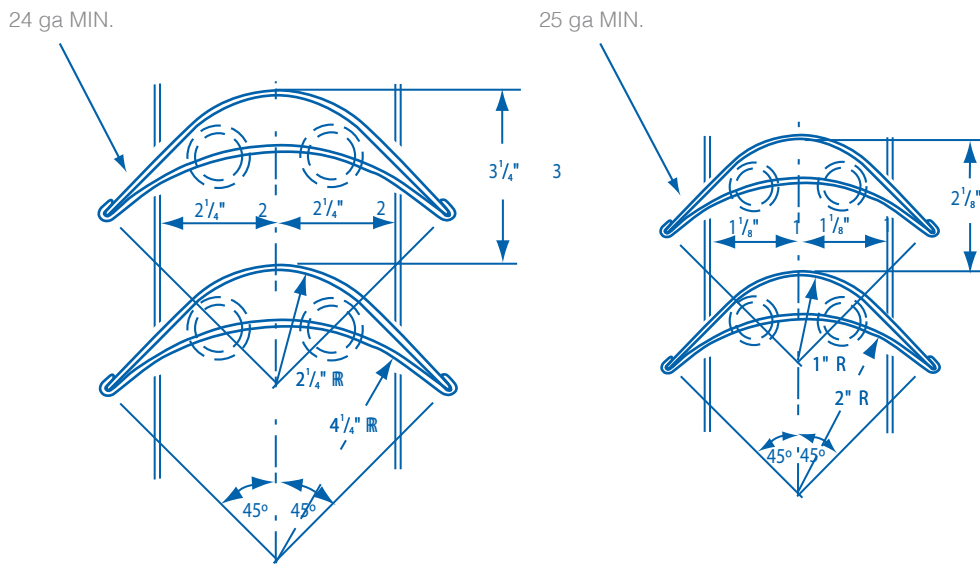

### Single Vanes

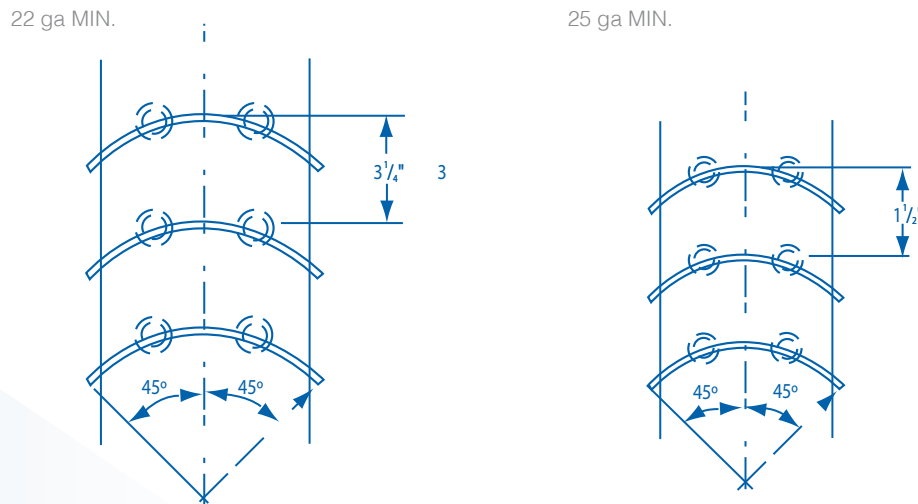





# SINGLE WALL RECTANGULAR

## Duct & Fittings

### TDC Connection

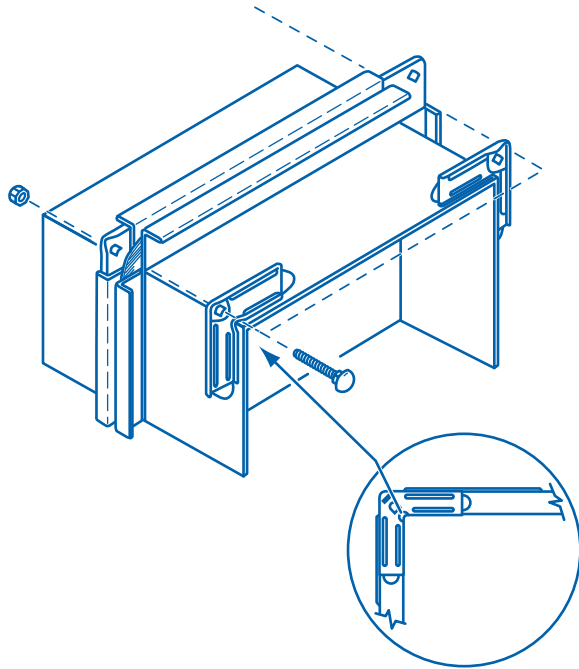

### Recommended Clip Spacing

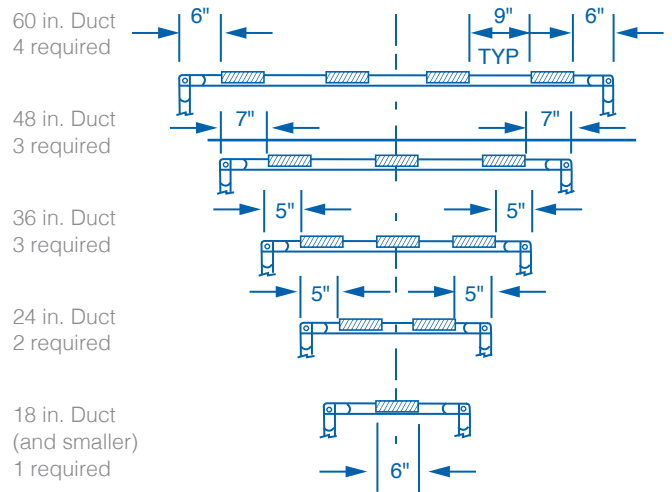

### Straight Duct

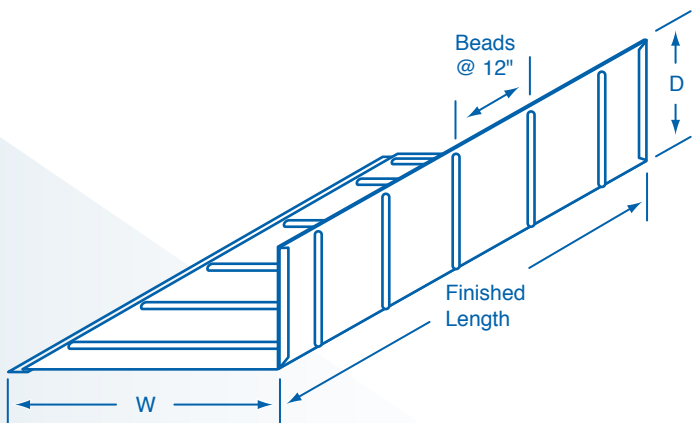

- 55 1/2" – Finished length with TDC
- 59" – Finished length with drive cleat ends
- 60" – Length with ends unfinished



### Square Throat / Square Heel 90° Elbow

With or without vanes

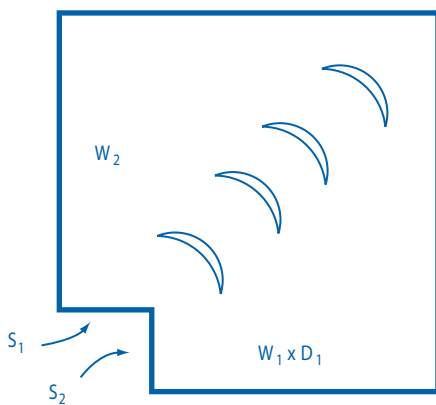

### Square Throat / Radius Heel 90° Elbow

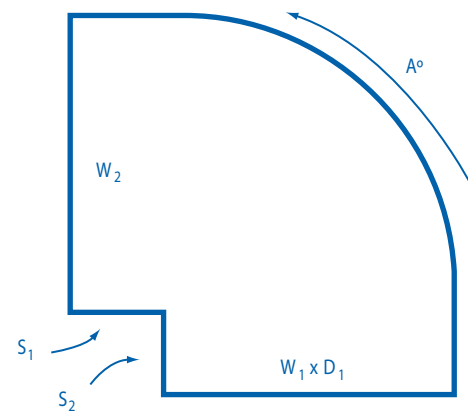

### Square Throat / Square Heel Elbow

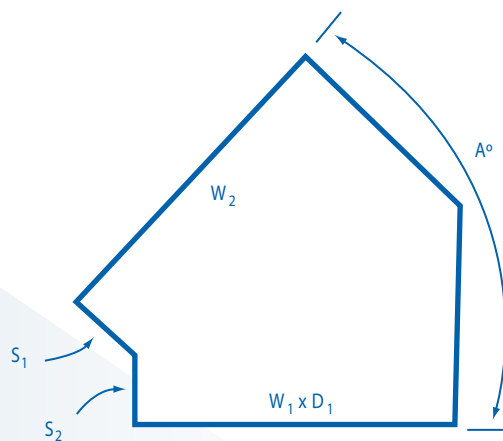

### Radius Elbow

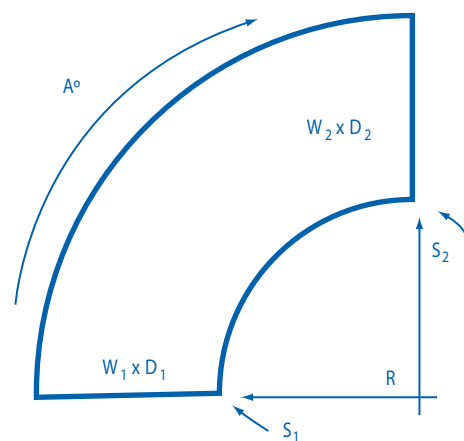



### Radius Offset Right

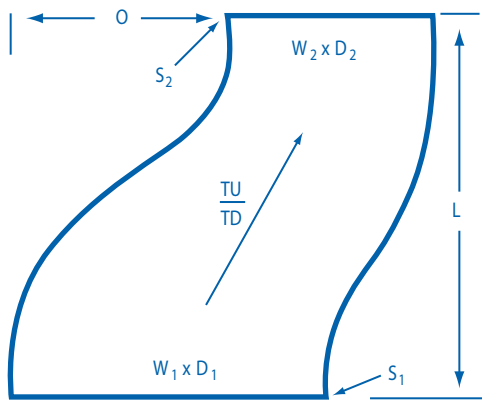

### Square Offset Right

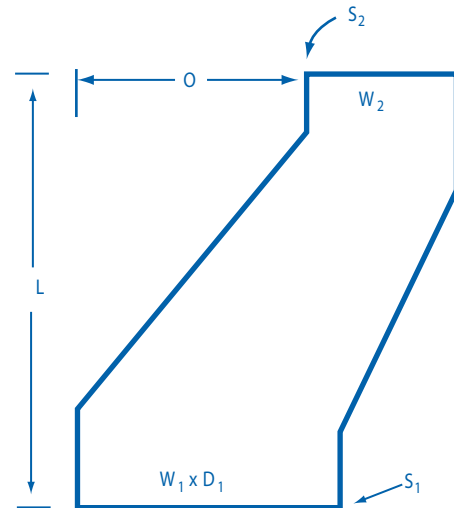

### Radius Offset Left

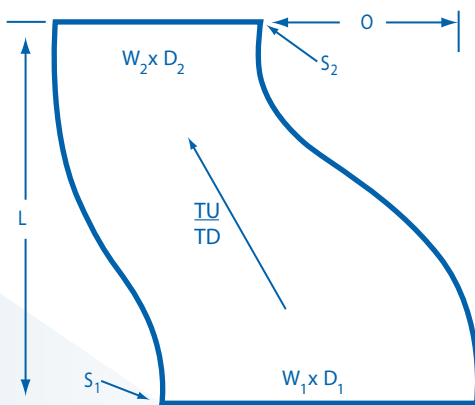

### Square Offset Left

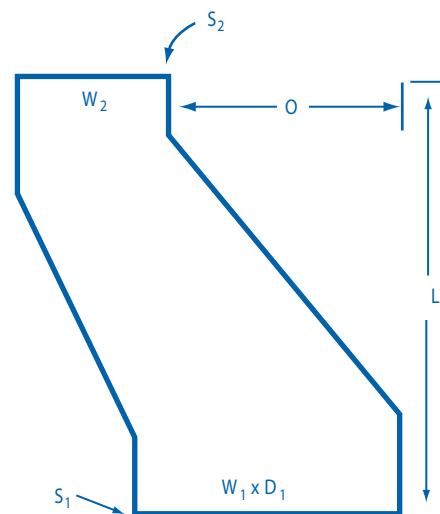



### Transition Straight Sides

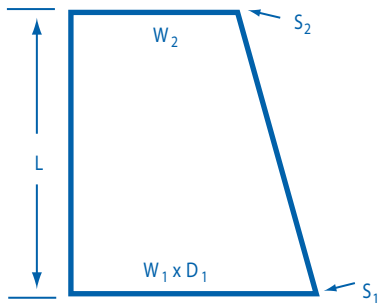

### Transition Offset Left

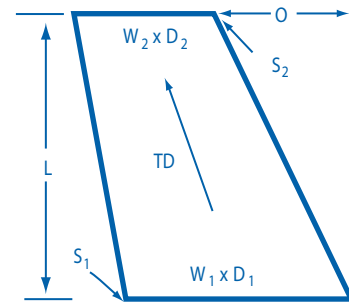

### Double Square Elbow

With or without vanes

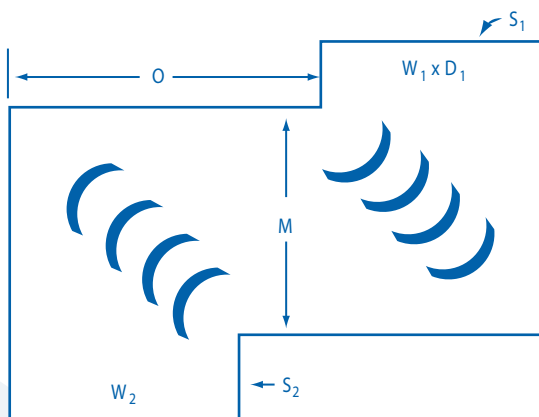

### Transition Offset Right

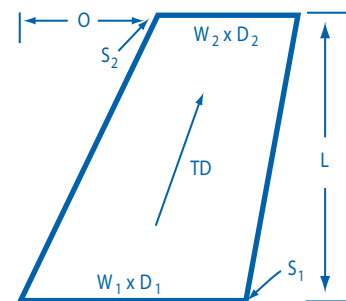



Radius Wye Branch

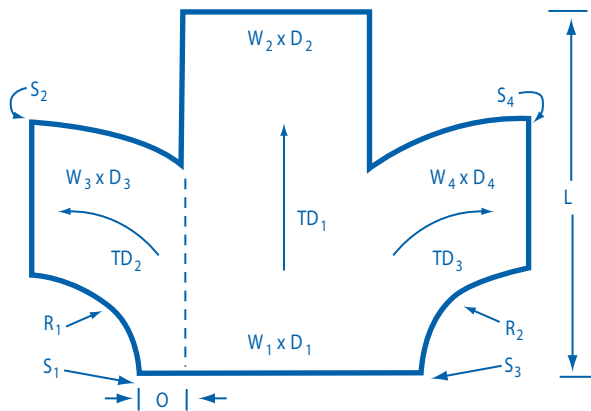

Wye

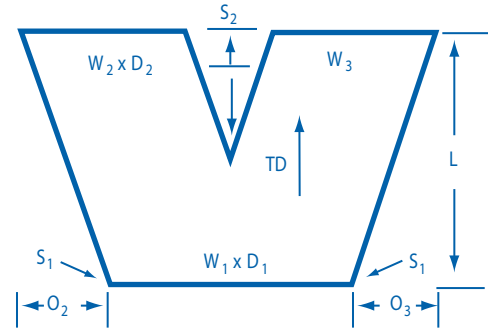

Radius Tee

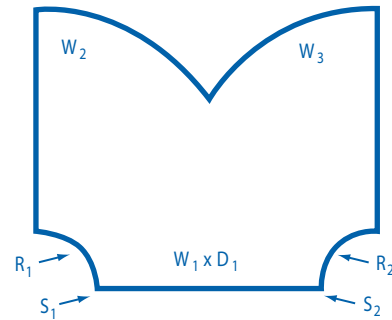

Square Tee

With or without vanes

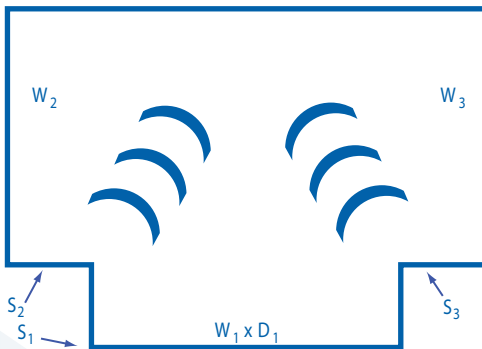

Radius Branch

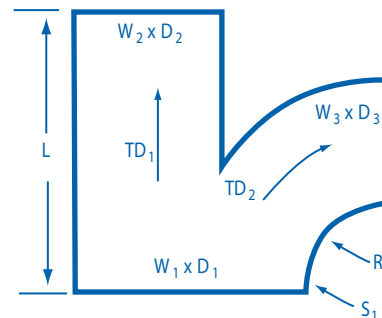



### Square to Round

---

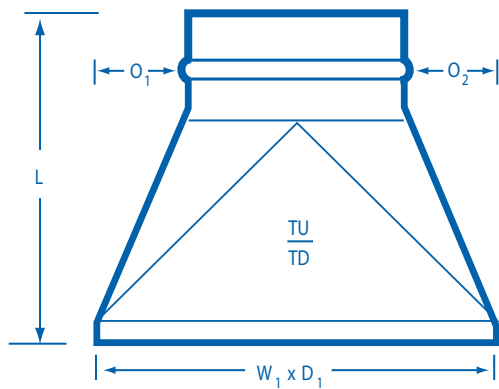

### Straight Tap

---

Available in outside or inside collar lock

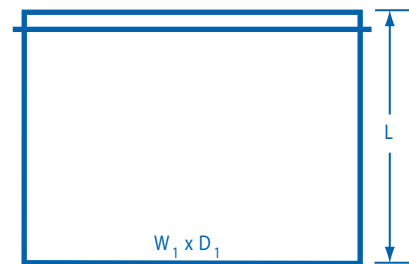

### Canvas / Flex Connector

---

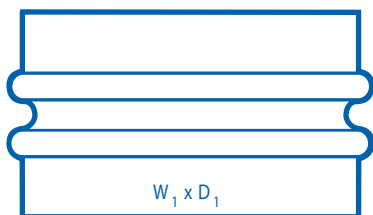

### Increased Tap

---

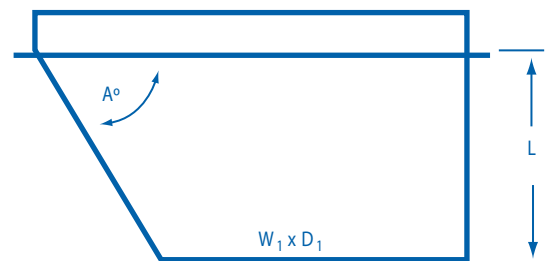



# SINGLE WALL RECTANGULAR

## Fittings



Square Throat  
Square Heel 90° Elbow

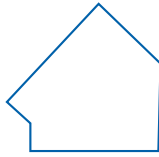

Square Throat  
Square Heel Elbow

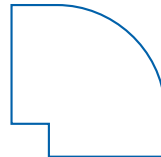

Square Throat  
Radius Heel Elbow

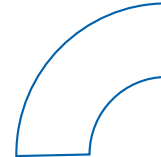

Radius Elbow



Radius Offset  
Right



Radius Offset  
Left



Square Offset  
Right

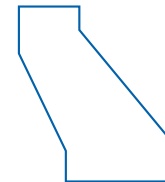

Square Offset  
Left



Transition Straight Sides

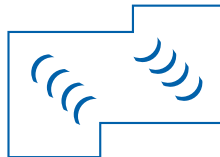

Double Square  
Elbow



Offset Left



Offset Right

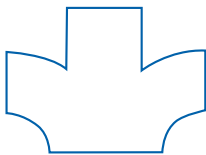

Radius Wye  
Branch

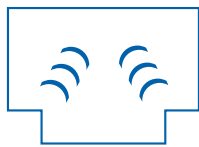

Square Tee



Wye



Radius Tee



Radius Branch



Square to Round

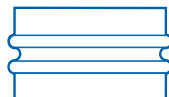

Canvas / Flex  
Connector



Straight Tap



Increased Tap